



Bulletin:  
C 2015R

# C SERIES



# Features

## Bleed Control Plate —

Addition of a control plate for selected valves, allows adjustable control of each exhaust port to provide accurate and inexpensive speed control.

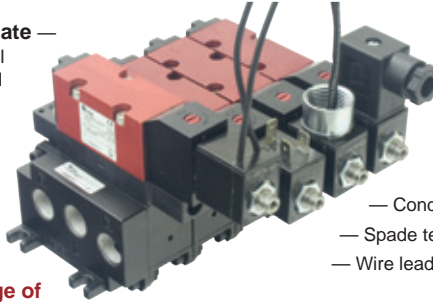

## Many Solenoid Electrical Connections.

— DIN connectors with cord grip or conduit connection

- Conduit connection
- Spade terminals
- Wire leads

## Complete range of AC & DC voltages.

— Coil can be rotated 180 degrees for maximum application flexibility (non Plug-In valves).

**C9 NEMA 4 Rated**

## Multipurpose Valve Function —

One basic 4-way valve for each valve series, which can be applied in a 3-way (by plugging port) or 4-way application to meet all your pneumatic cylinder applications.

— **Manual override** Standard on all solenoid actuators; ability to set-up and test equipment without an electric signal.

— **Regulator Plate** — provides 4-way or 5-way pressure regulation.

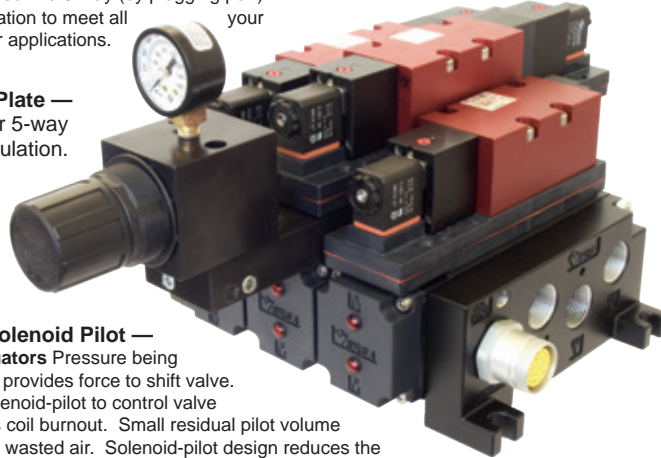

## Solenoid Pilot —

**type Actuators** Pressure being controlled provides force to shift valve. Use of solenoid-pilot to control valve eliminates coil burnout. Small residual pilot volume minimizes wasted air. Solenoid-pilot design reduces the power consumption required to shift and hold valve

**Multi-Pin Connector on Plug-In Manifold**  
This option reduces installation costs via a fully pre-wired Multi-Pin connector.

**Large Flow Area**  
Largest Cv rating for package size.  
C5= 0.75  
C7= 1.5  
C9= 4.1  
Provides faster cylinder response. Smaller size valve saves space.

## — Anodized Aluminum, Stainless Steel and Brass Construction

All wetted parts resist damage due to corrosion.

— **Epoxy molded coils** for moisture resistance & heat dissipation.

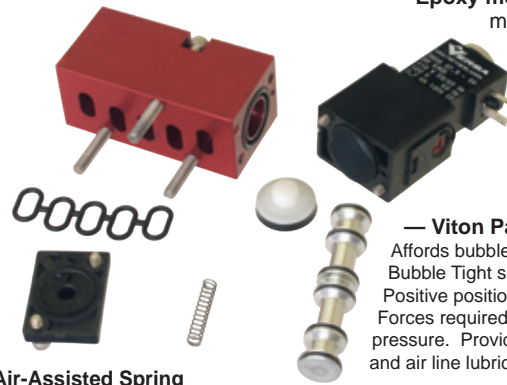

— **Air-Assisted Spring Return** Air boosts spring for positive valve return.

## — Viton Packed Balanced Spool

Affords bubble tight sealing throughout entire pressure range. Bubble Tight service reduces cost due to wasted air. Positive positioning of actuated device when utilizing 3-position valves. Forces required to actuate the valve are unaffected by the controlled pressure. Provides large compatibility range of media (air/inert gas) and air line lubricants.

Rated for 20 million bubble tight cycles on lubricated service (10 million on non-lubricated service). Superior wear resistance characteristics.

**Plug-In Electrical Connection with Unique Circuit Board Design**  
Provides easy and quick connect/disconnect of electrical connections.

— **Plug-In plate Connects valve to manifold.**

Same junction box is utilized for both single and double solenoid valves. All coils are factory pre-wired to junction box.

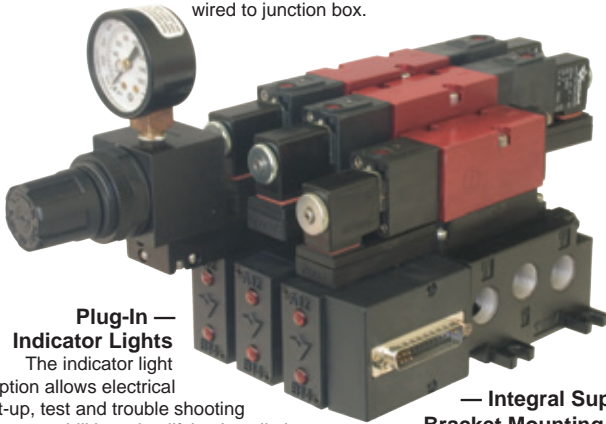

**Plug-In — Indicator Lights**

The indicator light option allows electrical set-up, test and trouble shooting capabilities, simplifying installation. Lights are easily retrofitted in the field.

— **Integral Support Bracket Mounting**

No extra parts or brackets are required in mounting complete valve/manifold assembly. Four very assessable mounting brackets simplify installation.

— **Three Screws Fasten Valve to Manifold**

Ease of installation and serviceability. No need to make or break any plumbing connections. Simple connect/disconnect of electrical connections when plug-in option is specified.

Junction boxes — can be retrofitted in the field.

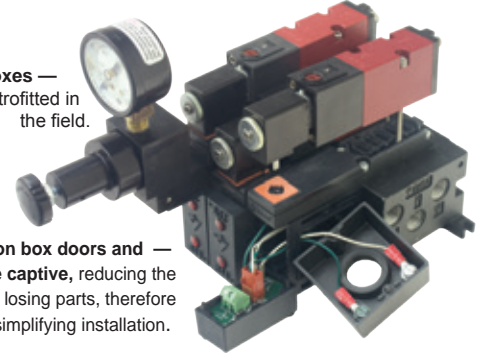

Junction box doors and — screws are captive, reducing the chance of losing parts, therefore simplifying installation.

— **Circuit board** with integral wiring terminal strip provides fast and easy installation.

**One Type of Manifold Within Each**

— **Size Series** for All Valve Actuator Types. Possible to intermix different types of actuators within the same manifold. One Manifold to inventory.

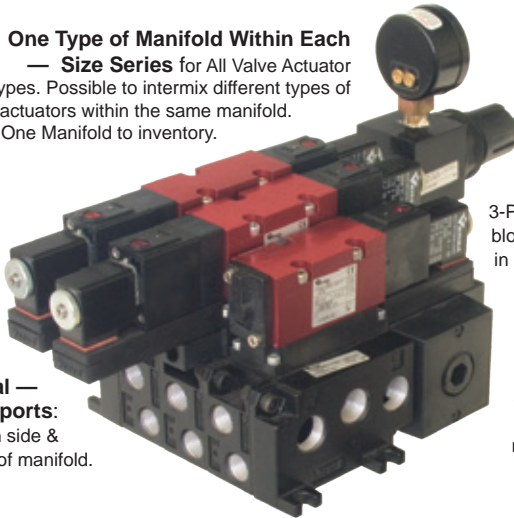

**Individual — cylinder ports:**

Located in side & bottom of manifold.

— **Single & Double Solenoids In 2 or 3 Position Valves**

All Double Solenoid 2 Position Valves are equipped with detent. 3-Position Valves offer choice of all ports blocked or cylinder ports open to exhaust in un-actuated position.

— **1/2" NPT Conduit connection** for ease of wiring. One on each side of manifold for mounting and wiring flexibility.

**Low Power Solenoid Option (Standard on Plug-In Valves)**

Inexpensive operating costs due to low power consumption and no need for additional power supplies.

Low power solenoids also operate at reduced heat; reducing the need for cooling or venting when applied in control panels.

“Ground” and Common” connections are pre-wired at factory to common terminal screws and are color coded (green/white), reducing installed cost.

**Common Inlet and Exhaust Galleries.**  
C5= 1/4" NPT or G1/4,  
C7= 3/8" NPT or G3/8  
C9= 1/2" NPT

**Powder Coated — Aluminum Manifolds & End Plates** Provides superior corrosion and strength characteristics and enhances appearance. Porting threads with integrity.

**Locating bosses —** on manifold and end plate interfaces assure proper installation and sealing.

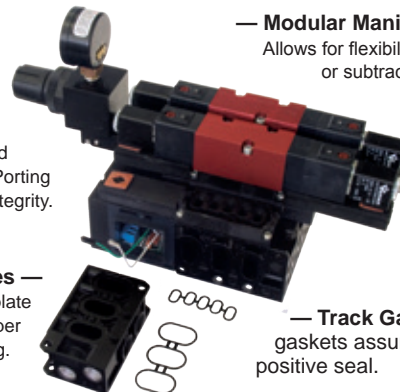

— **Modular Manifold Stacking Design**

Allows for flexibility; Valve stations can be added or subtracted in the field.

— **Vibration Resistant Fasteners** retain manifold integrity under the toughest of conditions.

— **Track Gasket Sealing** Custom designed gaskets assure proper installation and a positive seal.

# The C Family



Versa's C-Series, C5, C7 & C9, valves are multi-purpose four-way, 5 port 2 position or 5 port 3 position, pilot operated pneumatic valves consisting of two body types, sideported and manifold mounted. Pilot supply can be either Inpilot or Expilot. A low power solenoid controls the pilot signal which provides the positive force for shifting the valve spool.

Double solenoid/pilot 5/2 models feature detented offset positions. Double solenoid/pilot 5/3 models feature a spring return to the unactuated center position with all ports blocked or exhaust ports open in the center position or cylinder ports open to inlet.

A balanced, packed spool is the flow controlling element of each valve. The balanced spool allows the force necessary to shift the valve to remain independent of the pressure of the medium being controlled. The use of elastomer sealing provides bubbletight operation thus enabling positive positioning of 3-position devices, and thrift of operation due to no waste of leaking air.



**The C5** is a four-way manifold mounted and body ported, two/three position (5/2 5/3) valves, with 1/8" NPT ports standard and ISO G thread optional. The manifold mounted valves are designed to be mounted on a stacking style manifold and can be manual, pilot or electrically operated with a variety coil options, as well as the Plug-In feature. An optional Pre-Wired sub D connector can support up to 12 valves on a manifold.

The body ported valves are of a universal flow design, solenoid, manual or pilot operated and can be mounted individually or side by side using #6 screws or on a 2 to 10 station rack mounted manifold (for more information on manual and pilot actuated valves see page 9).



**The C7** is a four-way manifold mounted and body ported, two/three position (5/2 5/3) valve, with 1/4" NPT ports standard and ISO G thread optional. The manifold mounted valves are designed to be mounted on a stacking style manifold and can be manual, pilot or electrically operated with a variety coil options, as well as the Plug-In feature. An optional Pre-Wired sub D connector can support up to 12 valves on a manifold.

The body ported valves are of a universal flow design, solenoid, manual or pilot operated and can be mounted individually or side by side using #8 screws or on a 2 to 10 station rack mounted manifold (for more information on manual and pilot actuated valves see page 9).



**The C9** is a four-way manifold mounted and body ported, two/three position (5/2 5/3) valve, with 1/2" NPT ports. The manifold mounted valves are designed to be mounted on a stacking style manifold and can be electrically operated with a variety coil options, as well as the Plug-In feature. An optional Pre-Wired Amphonal 19 pin connector can support up to 8 valves on a manifold.

The body ported valves are of a universal flow design, solenoid, or pilot operated and can be mounted individually or side by side using 1/4" screws (for more information on pilot actuated valves see page 9).



**Overrides** Four types of overrides are available: Standard, Suffix Detail -G, -M and -CML. The standard is a push twist to lock, requires no call out. -G is a guarded momentary contact, -M is an unguarded momentary contact and -CML is a raised grip, push twist to lock.

Two styles are available depending on the solenoid pilot cap used; engineered polymer or aluminum. The engineered polymer (shown extreme left top to bottom) -CML, -M & standard. The aluminum (shown left top to bottom) -CML, -M, -G & standard (see electrical page 15 for applicable coil and override).



# Technical

## Materials Valves

Valve body, plunger - Anodized Aluminum  
 Actuating caps:  
   Solenoid (Standard) – Anodized Aluminum  
   Solenoid (Low-Watt) - Synthetic Resin  
   Spring Cap – Synthetic Resin  
 Pilot Piston - Synthetic Resin  
 Valve Seals: Plunger & Body - FKM (fluorocarbon)  
   Pilot Piston - NBR (nitrile)  
 Solenoid Parts (wetted) - 304, 430F Stainless Steel and Brass  
 Screws - Stainless Steel  
 Plug-In Plate - Synthetic Resin

## Materials Manifolds

Manifold, End Plates - Die cast Aluminum, powder coat-epoxy painted  
 Bleed Control Plate, Junction Box - Synthetic Resin  
 Regulator Accessory Plate - Black Anodized Aluminum  
 Station Blank - Black Oxide Steel  
 Track-gaskets - NBR (nitrile)  
 Screws: Manifold to Manifold - Black Oxide Steel  
 Valve to Manifold - Stainless Steel

## Temperature

Ambient Range -15°C (5°F) to +50°C (125°F)

## Flow

C5: Cv (Kv) average all ports: 0.75 (11)  
 C7: Cv (Kv) average all ports: 1.5 (22)  
 C9: Cv (Kv) average all ports: 4.1 (59.5)

## Installation

C Series valves have no limitations on mounting orientation.

## Filtration & Lubrication

40 to 50 micron filtration, and use of general purpose, non-detergent lubricating oil (ISO, ASTM) Grade 32 in controlled air is recommended.

## Operating Pressure

Valve Type	Actuation	Pilot Type	Size Series	Operating Pressure Range	Auxiliary Pilot Pressure
5/2 & 5/3	Single solenoid or Single pilot-spring return	Inpilot	C5	15-115 psi (1-8 bar)	none required
			C7	25-115 psi (1.7-8 bar)	
			C9	30-150 psi (2.1-10.3 bar)	
	Double solenoid or Double pilot-spring centered	Expilot	C5	Vacuum-115 psi (Vacuum-8 bar)	15-115 psi (1-8 bar)
			C7	Vacuum-115 psi (Vacuum-8 bar)	25-115 psi (1.7-8 bar)
			C9	Vacuum-150 psi (Vacuum-10.3 bar)	30-150 psi (2.1-10.3 bar)
5/2	Double solenoid-momentary contact	Inpilot	C5	10-115 psi (0.7-8 bar)	none required
			C7	15-115 psi (1-8 bar)	
			C9	20-150 psi (1.4-10.3 bar)	
	Double solenoid-momentary contact or Double pilot-momentary pressure	Expilot	C5	Vacuum-115 psi (Vacuum-8 bar)	10-115 psi (0.7-8 bar)
			C7	Vacuum-115 psi (Vacuum-8 bar)	15-115 psi (1-8 bar)
			C9	Vacuum-150 psi (Vacuum-10.3 bar)	20-150 psi (1.4-10.3 bar)
5/2 & 5/3	Manual-Lever, Button or Rotary switch		C5	Vacuum-115 psi (Vacuum-8 bar)	not applicable
			C7	Vacuum-115 psi (Vacuum-8 bar)	

# Selector

## Valve Selector

C	SG			-	4	5
VALVE SERIES	ACTUATING DEVICES			FUNCTION TYPE OF VALVE	VALVE PORT SIZE	
	Actuation	Description	Valve Series			
C S E R I E S	SG	Spring Return, <b>Solenoid</b>	Spring pushes valve spool	C5, C7 & C9	4 Four-Way 5 Four-Way	2 1/8" NPT 3 1/4" NPT 5 1/2" NPT
	GG	Solenoid - <b>Pilot</b>	2 position valve, dual solenoid	C5, C7 & C9		
	XX	Spring Centering, <b>Solenoid</b>	Solenoid-Pilot Spring Centering. For 3 position solenoid operated valves	C5, C7 & C9		
	SP	Spring Return, <b>Pilot</b>	Spring pushes valve spool	C5, C7 & C9		
	PP	Pressure <b>Pilot</b>	2 position dual pilot valve	C5, C7 & C9		
	JJ	Spring Centering, <b>Pressure Pilot</b>	For 3 position pilot operated valves	C5, C7 & C9		
	SI	Spring Return, <b>Palm Button</b>	Spring pushes valve spool	C5, C7		
	BI	Spring Centering, <b>Palm Button</b>	For 3 position manually operated valves			
	SL	Spring Return, <b>Lever</b>	Spring pushes valve spool			
	BL	Spring Centering, <b>Lever</b>	For 3 position manually operated valves	C5, C7		
	ZL	Two-Detent, <b>Lever</b>	For 2 position manually operated valves			
	UL	Three-Detent, <b>Lever</b>	For 3 position manually operated valves	C5, C7		
	ZI	Two-Detent, <b>Palm Button</b>	For 2 position manually operated valves	C5, C7		
	UI	Three-Detent, <b>Palm Button</b>	For 3 position manually operated valves			
ZA	Two-Detent, <b>Rotary Switch*</b>	For 2 position manually operated valves	C5, C7			
UA	Three-Detent, <b>Rotary Switch*</b>	For 3 position manually operated valves				
*Rotary Switch must have-357 Suffix Detail						

## Manifold Selector

C5M	-	4	2	0	2	-	6	-
Manifold Type Valve Size		Valve Type	Cylinder Port Size	Port Type	Cylinder Port Location		Number of Stations	
C5M - 1/8"		4 - 4-Way	2 - 1/8"	0 - NPT	0 - Rack Mounted: (cylinder ports are in the valve)  2 - Stacking: Side  3 - Stacking: Side & Bottom		Rack Mounted 2 - 10	
C7M - 1/4"			3 - 1/4"	6 - ISO Threads			Stacking Manifold 2 - 10	
C9M - 1/2"			4 - 3/8" 5 - 1/2"				Multi Pin Connector C5 & C7 2 - 12  C9 2 - 8	

Note: ISO ports available on both valves and manifolds. Contact factory for part number.

2		2		-	243		-	Coil Code
BODY DETAILS		SPOOL DETAILS (flow patterns)			SUFFIX DETAILS			
0	<b>SIDE PORTED-EXPILOT</b> Body with integral, pipe threaded ports. This type of body is directly connected to pressure lines and is used for mechanical, manual and Expilot* type solenoid or pilot actuated valves.	2	<b>FOUR-WAY VALVES</b> Two Position Standard flow pattern: inlet alternately open to one cylinder port; opposite cylinder port alternately open to exhaust.		<b>Coil/Coil Housing</b> -027 0.75 Low Watt DC Solenoid Operator -043 Low Watt AC/DC Solenoid Operator -228L ½" conduit -243 Wire leads -C50 ½" conduit, 8 watt, steel housing -CB 48" coil wire lead length -CD 72" coil wire lead length -HC DIN interface, pg grip cord connection -HCC DIN interface, ½" conduit connector -HCCL DIN interface, ½" conduit connector with light -HCL DIN interface, pg grip cord connection with light -HT High temperature coil, class H -LA Low power, 0.85 watt -LB Low power, 1.8 watt -PC Potted coil, NEMA 4/4X, female hub			Solenoid actuated valves require a Coil Code that indicates the specific coil current/frequency and voltage. The Coil Code consists of a letter to indicate the current frequency:  <b>Rating Code:</b> A= 60Hz frequency D= Direct Current (DC) E= 50Hz frequency  Three numbers follow the Rating Code to indicate voltage: <b>Examples:</b> <b>Voltage Code</b> 24V60 = 024 120V60 = 120 24VDC = 024
1	<b>MANIFOLD MOUNTING – EXPILOT</b> Body-ported for manifold mounting. This type of body is screw connected to a manifold that is connected to pressure lines and is used for mechanical, manual and Expilot* type solenoid or pilot actuated valves.		<b>FOUR-WAY VALVES</b> Three Position (Offset flows as standard flow patterns, above) Center Position		<b>Hazardous Service Solenoids</b> -XN ATEX Flameproof solenoid -XX Hazardous Location Solenoid			
2	<b>SIDE PORTED – INPILOT</b> Body same as "0" above, except it has an auxiliary internal passage to supply Inpilot** type solenoid and pilot actuators.	3	All ports blocked		<b>Manual Overrides</b> -G Override, guarded -CML Override, un-guarded, locking -M Override, un-guarded, non-locking			
3	<b>MANIFOLD MOUNTING – INPILOT</b> Body same as "1" above, except it has internal auxiliary passage to supply Inpilot** type solenoid and pilot actuators	4	Cylinder ports open to exhaust		<b>Special Service/Lubrication</b> -55A FDA approved -55G Dow High vacuum -55M Dow Molykote 33 -H2 ⅝" exhaust adapter -L14 Dust filter on solenoid exhaust -ET High Temp Service w/o override (C5 & C7) -ETM High Temp Service with override (C5 & C7)			
	*Separate pressure line connection needed to supply solenoid-pilot,  **Internal auxiliary porting supplies media pressure to solenoid-pilot	8	Inlet(s) open to both cylinder ports					

PMR		-	SSD	-	XS_	D024
Multi-Pin Connector			Surge Suppression		Isolation Plug	Voltage Code (required for Lights)
None	Non Plug-In manifold		SSD		XS_ - Supply XE_ - Exhaust	D024 - DC 24 Volt A120 - AC 120 Volt A240 - AC 240 Volt D024 - DC 24 Volt
P	Plug-In manifold		DC coils only		(requires location - which section to be Isolated)	see definition last column above
PL	Plug-In manifold with lights*				Example XS3 is the supply port 3rd interface from the left looking at cylinder ports	
PM	Multi-Pin connector left hand side					
PML	Multi-Pin connector left hand side with lights*					
PMR	Multi-Pin connector right hand side					
PMRL	Multi-Pin connector right hand side with lights*					
*Lights require voltage call out, see last column						

# Solenoid Valves

## Manifold Mounted Valves Size & Function

	Actuation	Valve Type	Operating Pressure Range psi	Pilot Type	Stacking Manifold Mount Valves			
					Standard	Low Watt		
					DC Only Option - 027	AC/DC Option - 043		
4-Way 2-Position 5/2	Single solenoid spring return	C5	15 - 115	Inpilot	CSG-4232-(* )	CSG-4232-027-(* )	CSG-4232-043-(* )	
			Vac - 115	Expilot	CSG-4212-(* )	CSG-4212-027-(* )	CSG-4212-043-(* )	
		C7	25 - 115	Inpilot	CSG-4332-(* )	CSG-4332-027-(* )	CSG-4332-043-(* )	
			Vac - 115	Expilot	CSG-4312-(* )	CSG-4312-027-(* )	CSG-4312-043-(* )	
C9	30 - 150	Inpilot	CSG-4532-(* )					
	Vac - 150	Expilot	CSG-4512-(* )					
4-Way 2-Position 5/2	Double solenoid	C5	10 - 115	Inpilot	CGG-4232-(* )	CGG-4232-027-(* )	CGG-4232-043-(* )	
			Vac - 115	Expilot	CGG-4212-(* )	CGG-4212-027-(* )	CGG-4212-043-(* )	
		C7	15 - 115	Inpilot	CGG-4332-(* )	CGG-4332-027-(* )	CGG-4332-043-(* )	
			Vac - 115	Expilot	CGG-4312-(* )	CGG-4312-027-(* )	CGG-4312-043-(* )	
		C9	20 - 150	Inpilot	CGG-4532-(* )			
			Vac - 150	Expilot	CGG-4512-(* )			
4-Way 3-Position 5/3	Double solenoid spring centered (all ports closed)	C5	15 - 115	Inpilot	CXX-4233-(* )	CXX-4233-027-(* )	CXX-4233-043-(* )	
			Vac - 115	Expilot	CXX-4213-(* )	CXX-4213-027-(* )	CXX-4213-043-(* )	
		C7	25 - 115	Inpilot	CXX-4233-(* )	CXX-4333-027-(* )	CXX-4233-043-(* )	
			Vac - 115	Expilot	CXX-4213-(* )	CXX-4313-027-(* )	CXX-4213-043-(* )	
		C9	30 - 150	Inpilot	CXX-4533-(* )			
			Vac - 150	Expilot	CXX-4513-(* )			
4-Way 3-Position 5/3	Double solenoid spring centered (cylinder ports open to Exhaust)	C5	15 - 115	Inpilot	CXX-4234-(* )	CXX-4234-027-(* )	CXX-4234-043-(* )	
			Vac - 115	Expilot	CXX-4214-(* )	CXX-4214-027-(* )	CXX-4214-043-(* )	
		C7	25 - 115	Inpilot	CXX-4334-(* )	CXX-4334-027-(* )	CXX-4334-043-(* )	
			Vac - 115	Expilot	CXX-4314-(* )	CXX-4314-027-(* )	CXX-4314-043-(* )	
		C9	30 - 150	Inpilot	CXX-4534-(* )			
			Vac - 150	Expilot	CXX-4514-(* )			
4-Way 3-Position 5/3	Double solenoid spring centered (Inlet open to cylinder ports)	C5	15 - 115	Inpilot	CXX-4238-(* )	CXX-4238-027-(* )	CXX-4238-043-(* )	
			Vac - 115	Expilot	CXX-4218-(* )	CXX-4218-027-(* )	CXX-4218-043-(* )	
		C7	25 - 115	Inpilot	CXX-4338-(* )	CXX-4338-027-(* )	CXX-4338-043-(* )	
			Vac - 115	Expilot	CXX-4318-(* )	CXX-4318-027-(* )	CXX-4318-043-(* )	
		C9	30 - 150	Inpilot	CXX-4538-(* )			
			Vac - 150	Expilot	CXX-4518-(* )			

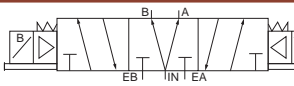
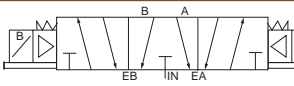
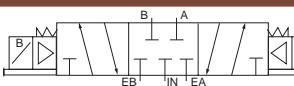
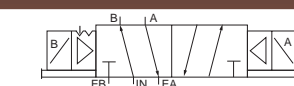
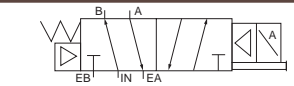

## Manifold Cylinder Port Size & Location

	Cylinder Port Size		Cylinder Port Location		Stacking Manifolds Non Plug-In		Stacking Manifolds Plug-In	
	1/8" NPT	1/4" NPT	Side Only	Side & Bottom	Manifold part Number	Mountable Valves, Typical	Manifold part Number	Mountable Valves
								Low Watt 027 or 043
C5	X		X		C5M-4202-(t)	CSG-4232-(* ) CGG-4232-(* ) CXX-4233-(* ) CXX-4234-(* )	C5M-4202-(t)-(tt)	CSG-4232-027-P-(* ) CGG-4232-027-P-(* ) CXX-4233-027-P-(* ) CXX-4234-027-P-(* )
		X	X		C5M-4302-(t)		C5M-4302-(t)-(tt)	CSG-4232-043-P-(* ) CXX-4233-043-P-(* ) CXX-4234-043-P-(* )
	X			X	C5M-4203-(t)		C5M-4203-(t)-(tt)	
	1/4" NPT	3/8" NPT						
C7	X		X		C7M-4302-(t)		C7M-4302-(t)-(tt)	CSG-4332-027-P-(* ) CGG-4332-027-P-(* ) CXX-4333-027-P-(* )
		X	X		C7M-4402-(t)	CSG-4332-(* ) CGG-4332-(* ) CXX-4333-(* ) CXX-4334-(* )	C7M-4402-(t)-(tt)	CSG-4332-043-P-(* ) CXX-4333-043-P-(* )
	X			X	C7M-4303-(t)		C7M-4303-(t)-(tt)	CGG-4332-043-P-(* ) CXX-4334-043-P-(* )
	1/2" NPT	1/2" NPT						
C9	X		X		C9M-4502-(t)	CSG-4532-(* ) CGG-4532-(* ) CXX-4533-(* ) CXX-4534-(* )	C9M-4502-(t)-(tt)	CSG-4532-P-(* ) CGG-4532-P-(* ) CXX-4533-P-(* )
	X			X	C9M-4503-(t)		C9M-4503-(t)-(tt)	CXX-4534-P-(* )



Manifold Mount Valves				Side Ported Valves			
Plug-In	Plug-In Low watt		Port Size	Standard	Low Watt		
	DC Only Option - 027	AC/DC Option - 043			DC Only Option - 027	AC/DC Option - 043	
	CSG-4232-027-P-(* )	CSG-4232-043-P-(* )	1/8" NPT	CSG-4222-(* )	CSG-4222-027-(* )	CSG-4222-043-(* )	
	-		1/8" NPT	CSG-4202-(* )	CSG-4202-027-(* )	CSG-4202-043-(* )	
	CSG-4332-027-P-(* )	CSG-4332-043-P-(* )	1/4" NPT	CSG-4322-(* )	CSG-4322-027-(* )	CSG-4322-043-(* )	
	-		1/4" NPT	CSG-4302-(* )	CSG-4302-027-(* )	CSG-4302-043-(* )	
CSG-4532-P-(* )	-		1/2" NPT	CSG-4522-(* )			
CSG-4512-P-(* )	-		1/2" NPT	CSG-4502-(* )			
	CGG-4232-027-P-(* )	CGG-4232-043-P-(* )	1/8" NPT	CGG-4322-(* )	CGG-4222-027-(* )	CGG-4222-043-(* )	
			1/8" NPT	CGG-4202-(* )	CGG-4202-027-(* )	CGG-4202-043-(* )	
	CGG-4332-027-P-(* )	CGG-4332-043-P-(* )	1/4" NPT	CGG-4322-(* )	CGG-4322-027-(* )	CGG-4322-043-(* )	
			1/4" NPT	CGG-4302-(* )	CGG-4302-027-(* )	CGG-4302-043-(* )	
CGG-4532-P-(* )			1/2" NPT	CGG-4522-(* )			
CGG-4512-P-(* )			1/2" NPT	CGG-4502-(* )			
	CXX-4233-027-P-(* )	CXX-4233-043-P-(* )	1/8" NPT	CXX-4223-(* )	CXX-4233-027-(* )	CXX-4233-043-(* )	
			1/8" NPT	CXX-4203-(* )	CXX-4203-027-(* )	CXX-4203-043-(* )	
	CXX-4233-027-P-(* )	CXX-4233-043-P-(* )	1/4" NPT	CXX-4323-(* )	CXX-4233-027-(* )	CXX-4233-043-(* )	
			1/4" NPT	CXX-4303-(* )	CXX-4203-027-(* )	CXX-4203-043-(* )	
CXX-4533-P-(* )			1/2" NPT	CXX-4523-(* )			
CXX-4513-P-(* )			1/2" NPT	CXX-4503-(* )			
	CXX-4234-027-P-(* )	CXX-4234-043-P-(* )	1/8" NPT	CXX-4224-(* )	CXX-4234-027-(* )	CXX-4234-043-(* )	
			1/8" NPT	CXX-4204-(* )	CXX-4204-027-(* )	CXX-4204-043-(* )	
	CXX-4334-027-P-(* )	CXX-4334-043-P-(* )	1/4" NPT	CXX-4324-(* )	CXX-4334-027-(* )	CXX-4334-043-(* )	
			1/4" NPT	CXX-4304-(* )	CXX-4304-027-(* )	CXX-4304-043-(* )	
CXX-4534-P-(* )			1/2" NPT	CXX-4524-(* )			
CXX-4514-P-(* )			1/2" NPT	CXX-4504-(* )			
	CXX-4238-P-027-(* )	CXX-4238-P-043-(* )	1/8" NPT	CXX-4228-(* )	CXX-4238-027-(* )	CXX-4238-043-(* )	
			1/8" NPT	CXX-4208-(* )	CXX-4208-027-(* )	CXX-4208-043-(* )	
	CXX-4338-P-027-(* )	CXX-4338-P-043-(* )	1/4" NPT	CXX-4328-(* )	CXX-4338-027-(* )	CXX-4338-043-(* )	
			1/4" NPT	CXX-4308-(* )	CXX-4308-027-(* )	CXX-4308-043-(* )	
CXX-4538-P-(* )			1/2" NPT	CXX-4528-(* )			
CXX-4518-P-(* )			1/2" NPT	CXX-4508-(* )			

## Manifold, Rack Mounted

### Notes:

\* Voltage options - see page 14-15

\*\* Low watt option (DC - 027, AC - 043 or none)

† The number of stations - 2-12

1/2" manifold limited to 8 stations with multi pin connector

†† None Non Plug-In manifold

P Plug-In manifold

PL Plug-In manifold with lights\*

PM Multi-Pin connector left hand side

PML Multi-Pin connector left hand side with lights\*

PMR Multi-Pin connector right hand side

PMRL Multi-Pin connector right hand side with lights\*



\* Lights require same voltage option as Solenoid valve being used

Rack Mounted Manifold		
Number of Stations	Manifold Part Number by Port Size	
	1/4" Ports	3/8" Ports
2	C5M-4300-2	C7M-4400-2
3	C5M-4300-3	C7M-4400-3
4	C5M-4300-4	C7M-4400-4
5	C5M-4300-5	C7M-4400-5
6	C5M-4300-6	C7M-4400-6
7	C5M-4300-7	C7M-4400-7
8	C5M-4300-8	C7M-4400-8
9	C5M-4300-9	C7M-4400-9
10	C5M-4300-10	C7M-4400-10
Mountable Solenoid Valves†		
	CSG-4222-(**)-(* )	CSG-4222-(**)-(* )
	CGG-4222-(**)-(* )	CGG-4222-(**)-(* )
	CXX-4223-(**)-(* )	CXX-4223-(**)-(* )
	CXX-4224-(**)-(* )	CXX-4224-(**)-(* )
	CXX-4228-(**)-(* )	CXX-4228-(**)-(* )

# Valves Side Ported

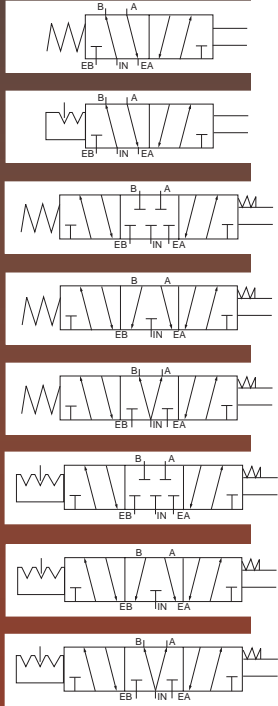
## Manually Actuated



FUNCTION			ACTUATION		
			LEVER 	BUTTON 	ROTARY SWITCH 
5/2	Spring return	C5 1/8" NPT	CSL-4202	CSI-4202	N/A
		C7 1/4" NPT	CSL-4302	CSI-4302	
	Two Detent	C5 1/8" NPT	CZL-4202	CZI-4202	CZA-4202-357
		C7 1/4" NPT	CZL-4302	CZI-4302	CZA-4302-357
5/3	Spring Centered (all ports blocked)	C5 1/8" NPT	CBL-4203	CBI-4203	N/A
		C7 1/4" NPT	CBL-4303	CBI-4303	
	Spring Centered (Cylinder ports open to exhaust)	C5 1/8" NPT	CBL-4203	CBI-4203	
		C7 1/4" NPT	CBL-4303	CBI-4303	
	Spring Centered (Inlet open to cylinder ports)	C5 1/8" NPT	CBL-4204	CBI-4204	
		C7 1/4" NPT	CBL-4304	CBI-4304	
	Three Detent (all ports blocked)	C5 1/8" NPT	CUL-4203	CUI-4203	CUA-4203-357
		C7 1/4" NPT	CUL-4303	CUI-4303	CUA-4303-357
	Three Detent (Cylinder ports open to exhaust)	C5 1/8" NPT	CUL-4204	CUI-4204	CUA-4204-357
		C7 1/4" NPT	CUL-4304	CUI-4304	CUA-4304-357
	Three Detent (Inlet open to cylinder ports)	C5 1/8" NPT	CUL-4208	CUI-4208	CUA-4208-357
		C7 1/4" NPT	CUL-4308	CUI-4308	CUA-4308-357

### Suffix Options for Manually Actuated Valves

- 218A Lever is rotated 90° counter clockwise from vertical upright position.
- 218B Lever is rotated 180° counter clockwise from vertical upright position.
- 218C Lever is rotated 270° counter clockwise from vertical upright position.
- 25B Large diameter 1.81" (46mm) black button.
- 25BG Large diameter 1.81" (46mm) green button.
- 25BR Large diameter 1.81" (46mm) Red button.
- 43 Additional panel nut for button or rotary switch valves. Reduces panel thickness from 0.56" (14.2) to 0.44" (11mm).

## Pilot Actuated

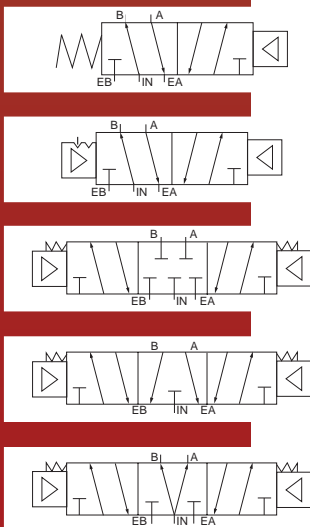

4-Way 2-Position 5/2	Single Pilot spring return	C5 1/8" NPT	CSP-4202-(* )
		C7 1/4" NPT	CSP-4302-(* )
		C9 1/4" NPT	CSP-4502-(* )
4-Way 2-Position 5/2	Double Pilot momentary contact	C5 1/8" NPT	CPP-4202-(* )
		C7 1/4" NPT	CPP-4302-(* )
		C9 1/4" NPT	CPP-4502-(* )
4-Way 3-Position 5/3	Double Pilot spring centered (all ports closed)	C5 1/8" NPT	CJJ-4203-(* )
		C7 1/4" NPT	CJJ-4303-(* )
		C9 1/4" NPT	CJJ-4503-(* )
4-Way 3-Position 5/3	Double Pilot spring centered (cylinder ports open to Exhaust)	C5 1/8" NPT	CJJ-4204-(* )
		C7 1/4" NPT	CJJ-4304-(* )
		C9 1/4" NPT	CJJ-4504-(* )
4-Way 3-Position 5/3	Double Pilot spring centered (Inlet open to cylinder ports)	C5 1/8" NPT	CJJ-4208-(* )
		C7 1/4" NPT	CJJ-4308-(* )
		C9 1/4" NPT	CJJ-4508-(* )

### Note:

Manual and pilot valves may be mounted on both fix length and stacking manifolds.

Example for stacking manifold: change valve part number from CUL-4303 to CUL-4313.



# Manifolds Plug-In

Versa's C manifold system provides single modular, stacking manifolds that can be joined together to form a very compact valve mounting platform up to 12 stations. Each module is able to mount any single solenoid or double solenoid actuated, 2 or 3 position valve within the specific C5, C7 or C9 series. Different types of valves and actuations within the same size series can be intermixed within the same manifold system. End Plates providing a common inlet and 2 common exhausts for each side of the manifold complete the assembly.

The modular concept allows systems to be easily changed in the field, or at any time, by addition or subtraction of valve stations or conversion to the Plug-In feature.

Cylinder ports are located in both the side and bottom of the manifold.



## Regulators

Sandwich regulators complete with pressure gauge with inlet port pressure control can be provided for 4-way function on any valve stations that require this feature. Dual pressure for 5-Way regulators also available (see full description on page 11).

## Bleed Control Plates

Bleed Control Plates that provide speed control through metering of the exhausts can be added as an option for any valve stations that require this feature (see page 12).



## Multi-Pin Connector (Suffix -PM)

The Multi-Pin option utilizes a 25 pin plug (male side) Sub-D connector on the C5 and C7 and a 19 pin, NEMA 4 connector on the C9; all are pre-wired and factory tested. All stations on Multi-Pin connector equipped manifolds are always wired for double solenoid valves, whether the valves are single or double solenoid. This allows the pneumatic equipment designer to change valve function easily if design changes occur.

Connection to a programmable logic controller is possible without the normal labor cost associated with solenoid valve wiring. Remove three screws and the valve is removed from the manifold without touching any electrical or pneumatic connections (see notes page 8 for additional suffix details and page 14 for individual pin identification).



## Indicator lights

Indicator lights are available in conjunction with the Plug-In electrical connection for all common voltages and are located in the cover of each junction box. These lights allow for easy manifold set-up and trouble shooting (see voltage codes page 6).

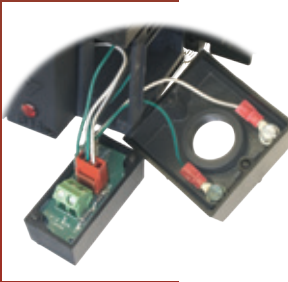

## Plug-In electrical connection (Suffix -P)

Use of the Plug-In electrical connection option simplifies wiring, installation and servicing. Wiring connections are made within a junction box adapter so that there is no hard wiring to any valve. Installation or removal of a valve, accomplished by simply loosening or tightening 3 valve mounting screws, and the valve is disconnected pneumatically and electrically.

The grounds and commons are pre-wired at the factory, so that only one wire connection is necessary for each solenoid and this is further simplified by a unique terminal strip mounted in the end cover of each box.

## Voltage Surge Protection (Suffix -SSD)

Surge limiting diodes are available for DC circuits (see pages 6 & 14).



## Intermediate Supply Manifolds

In applications where air flow capacity might be compromised due to several valves functioning at the same time or where controlled accessories require large volumes, Intermediate Supply Manifolds can be inserted into the manifold assembly at strategic intervals and additional inlet supply can be connected to these Supply Ports in order to increase the available volume of air. Consult factory for application assistance.



## Isolation Disc (Suffix -XS\_)

Isolation Discs are small gasketed shields that can be placed between manifold stations, to effectively isolate each group of valves that utilize the same pressure. For example, a five station assembly could have two stations functioning at 50 psi and three stations functioning at 100 psi by simply placing an Inlet Isolation Disc at the intersection of valve station 2 & 3 (see page 6).



## Spacer Plate

Required on C5 & C7 stacking manifold for mounting adjacent valves with hazardous service electrical operators or when mounting side by side regulators (see page 12).

# Regulators

## Regulators Plug-In Manifold

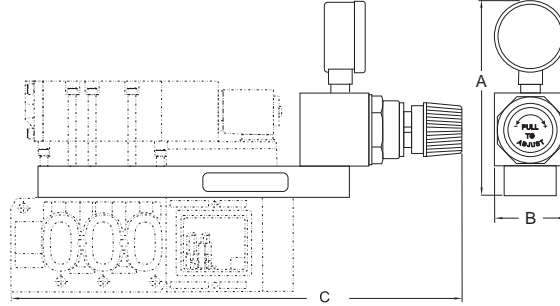

Series	Dimensions		
	A	B	C
C5	3.79" (96.3)	1.25" (31.6)	8.94" (227.1)
C7	4.04" (102.6)	1.5" (38.1)	9.4" (238.8)
C9	5.33" (135.4)	2.14" (54.4)	13.67" (347.2)

Metric dimensions in mm shown in parenthesis.

Series	4 way		5 WAY (Dual pressure 4-Way)		Pressure Range psi
	Non Plug-In	Plug-In	Non Plug-In	Plug-In	
C5	C5AR-4060MG	C5AR-4060MG-P	NA	NA	5-60
	C5AR-4125MG	C5AR-4125MG-P	NA	NA	10-125
	Not Available	Not Available	C7AR-5010MG	C7AR-5010MG-P	1-10
C7	Not Available	Not Available	C7AR-5030MG	C7AR-5030MG-P	3-30
	C7AR-4060MG	C7AR-4060MG-P	C7AR-5060MG	C7AR-5060MG-P	5-60
	C7AR-4125MG	C7AR-4125MG-P	C7AR-5125MG	C7AR-5125MG-P	10-125
	C9AR-4030MG	C9AR-4030MG-P	C9AR-5030MG	C9AR-5030MG-P	3-30
C9	C9AR-4060MG	C9AR-4060MG-P	C9AR-5060MG	C9AR-5060MG-P	5-60
	C9AR-4125MG	C9AR-4125MG-P	C9AR-5125MG	C9AR-5125MG-P	10-125

**Notes:**

- 1) Regulator Assembly includes gauge, valve mounting screws and track-gasket.
- 2) For side by side mounting of regulators or for regulators on every station, consult factory.
- 3) Regulators for use with INPilot type valves only.
- 4) For 4-way type regulator, must specify 4-way valve. For 5-way type regulator, must specify 5-way valve. Change first 4 in valve part number to 5, for example, CSG-4332-043 changes to CSG-5332-043.
- 5) Minimum manifold inlet pressure based on valve type.

### SINGLE PRESSURE (4-WAY) REGULATOR FLOW DIAGRAM

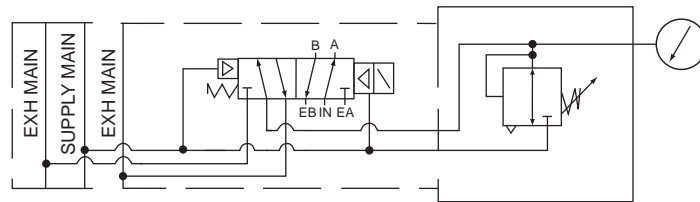

Flow Diagram above shows one single solenoid valve mounted on the Regulator Assembly.

### DUAL PRESSURE (5-WAY) REGULATOR FLOW DIAGRAM

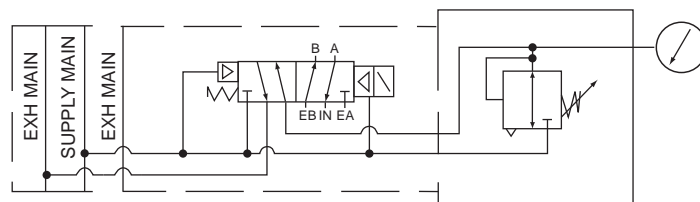

Flow Diagram above shows one single solenoid valve mounted on the Regulator Assembly. Supply Main pressure is supplied to the 'EB' (5) port and Regulated pressure is supplied to the 'EA' (3) port.

# Regulators & Accessories

## Regulators Extruded Manifold

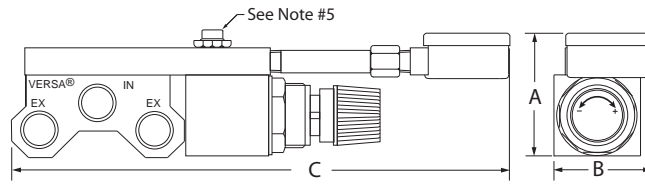

Series	Dimensions		
	A	B	C
C5	2.12" (53.8)	1.25" (31.8)	6.79" (172.5)
C7	2.27" (57.7)	1.7" (42.4)	8.66" (220)

Metric dimensions in mm shown in parenthesis.

4 way		5 WAY (Dual pressure 4-Way)		Pressure Range psi
C5	C7	C5	C7	
C5AR-4010G	C7AR-4010G	C5AR-5010G	C7AR-5010G	1-10
C5AR-4030G	C7AR-4030G	C5AR-5030G	C7AR-5030G	3-30
C5AR-4060G	C7AR-4060G	C5AR-5060G	C7AR-5060G	5-60
C5AR-4125G	C7AR-4125G	C5AR-5125G	C7AR-5125G	10-125

### NOTES:

- 1) Regulator Assembly includes valve mounting screws and O-rings and can only be mounted on every other station. Alternate regulator assemblies for adjacent stations.
- 2) All valves must be EXPilot type. No auxiliary pilot pressure required (see diagrams).
- 3) Minimum manifold inlet pressure required is based on valve type. See Technical Information page 5.
- 4) C7 only: regulator assembly product numbers listed are for use with Expilot solenoid operated valves only. For pilot or lever operated valves add "P" to the product number shown. FOR EXAMPLE: C7AR-4010GP
- 5) C7 only: assemble the adapter assembly flush in the pilot port of solenoid valve using a 9/16" wrench.

## Accessories Selection Guide

### Plug-In Manifold Bleed Control

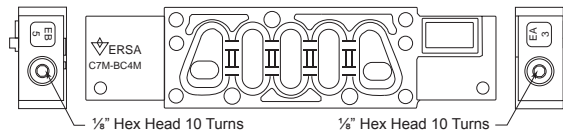

C5	C5M-BC4M
	C5M-BC4M-P For Low Watt Plug-In valves
C7	C7M-BC4M
	C7M-BC4M-P For Low Watt Plug-In valves
C9	C9M-BC4M
	C9M-BC4M-P For Low Watt Plug-In valves

### Plug-In Manifold Station Blank



C5	C5M-SB4M
C7	C7M-SB4M
C9	C9M-SB4M

### Extruded Manifold Bleed Control

C5: C5M-BC4  
C7: C7M-BC4

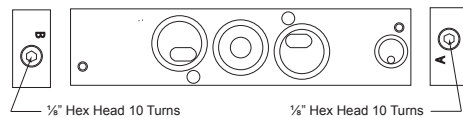

### Extruded Manifold Station Blank

C5: C5M-SB4  
C7: C7M-SB4

















### Plug-In Manifold Spacer Plate



Hazardous Service and non Plug-In Valves	C5	C5M-SP4M	0.55" wide
	C7	C7M-SP4M	0.40" wide
Plug-In Valves	C5	C5M-SP4M-P	0.55" wide
	C7	C7M-SP4M-P	0.40" wide

# Electrical

Coil Description	SUFFIX DETAIL by SERIES			SOLENOID OPERATOR TYPE	CONTINUOUS DUTY COILS		
	C5	C7	C9		Type	Nominal Power	
						AC	DC
 3 spade terminals, 11 mm, Mini DIN (DIN 43650 Form "B"). UL CSA Overrides G, M, & CML*	Std	Std	Std	Coils with spade terminals (for Mini DIN connector, NEMA 4/IP65)	CLASS F, Epoxy encapsulated, Rated voltage continuous duty 100%	C5/C7 8.5 Watts	C5/C7 10.5 Watts
 3 spade terminals, 11 mm, for use with Mini DIN connector (DIN 43650 Form "B"). Pg9 cord grip NEMA 4. UL CSA Overrides G, M, & CML*	-HC	-HC	-HC			C9 5 Watts	C9 4.8 watts
 3 spade terminals 11 mm, for use with 1/2" NPT Mini DIN connector. (DIN 43650 Form "B"). Overrides G, M, & CML*	HCC	HCC	-HCC				
 Two leads (flying leads). Overrides G, M, & CML*	-243	-243	-C15 -243	CLASS F, Epoxy encapsulated, Rated voltage continuous duty 100%	C5/C7/C9 8.5 Watts	C5/C7/C9 10.5 Watts	
 1/2" NPT conduit entry; integrally molded coil & conduit entry, NEMA 4/IP65. Overrides G, M, & CML*	-228L	-228L	-C15 -228L				
 3 spade terminals, 11 mm, Mini DIN for use with Versa socket on Plug-In manifolds C9. (DIN 43650 Form "B") NEMA 4/IP65. Overrides G, M, & CML*	NA	NA	-P		5 Watts	4.8 Watts	
 1/2" NPT conduit, carbon steel, chromate coated. Overrides G, M, & CML*	C50	C50	C50	CLASS F, Epoxy encapsulated, Rated voltage continuous duty 100%	6 Watts	7 Watts	
 1/2" NPT conduit entry; potted coil NEMA 4 & 4x, 11, 12, and 13 carbon steel, chromate coated. Overrides G, M, & CML*	PC	PC	PC				
<b>LOW-WATT OPTION 027, 043</b>							
 Coil 3 spade terminals, 8 mm, Micromini DIN (DIN 43650 Form "C"). Overrides M & CML*	STD	STD	NA	LOW-WATT coils with spade terminals (For Micromini DIN style 8 mm connector, NEMA 4/IP65) or wire leads or LOW-WATT PLUG-I	Option 027		0.75 Watt
 3 spade terminals, 8 mm, for use with Micromini DIN connector. Pg9 cord grip NEMA 4 (DIN 43650 Form "C"). Overrides M & CML*	-HC	-HC	NA		043	CLASS F, Epoxy encapsulated, Rated voltage continuous duty 100%	3.7 @50 Hz 3.2 to 3.1VA @60Hz
 Two leads (flying leads). Overrides M & CML*	-243	-243	NA				
 Coil with 3 spade terminals, 8 mm, Micromini DIN for use with Versa socket on Plug-In manifolds C5 & C7 (DIN 43650 Form "C"). Overrides M & CML*	NA	-P	NA				
<b>HAZARDOUS LOCATION</b>							
 Hazardous Locations, 1/2" NPT conduit, NEMA 7 & 9.	-XX	-XX	-XX-	CLASS F, Epoxy encapsulated, Rated voltage continuous duty 100%		5.6 Watts	7.2 Watts
 Hazardous Locations, 1/2" NPT conduit, NEMA 4/4X, 7 & 9. Other Hazardous Location coils available consult factory	-PC -XX	-PC -XX	-PC -XX				

\*for more information on overrides see page 3

## MULTI PIN CONNECTORS

CONTINUOUS DUTY COILS									
Certs	AC Voltage		Inrush	Holding		DC Voltage			Inrush & Holding amp
	Volts/Hz	Coil Code #	Amp	Amp	Ohm	Volts	Coil Code #	Ohm	
UL CSA	<b>C9</b>								
	24/60		0.458	0.354	31.6				
	110/50	A024 E110	0.458	0.354	615	6	D006	6.8	
	120/60	A120 E220	0.092	0.071	615	12 24	D012	31.6	-
	220/50	A240	0.092	0.071	3400	48	D024	121	
	240/60		0.045	0.035	3400		D048	458	
	<b>C5 &amp; C7</b>								
	24/60		0.63	0.50	26				
	110/50		0.13	0.10	647				0.87
	120/60	A024 E110	0.13	0.10	647	12 24	D012	15	0.43
220/50	A120 E220	0.06	0.05	2790	48	D024	55	0.22	
240/50	E240 A240	0.06	0.05	2790		D048	222		
240/60		0.06	0.05	2790					
UL CSA	24/60		0.63	0.50	26				
	110/50		0.13	0.10	647				0.87
	120/60	A024 E110	0.13	0.10	647	12 24	D012	15	0.43
	220/50	A120 E220	0.06	0.05	2790	48	D024	55	0.22
	240/50	E240 A240	0.06	0.05	2790		D048	222	
	240/60		0.06	0.05	2790				
UL CSA	<i>See C9 Above for Coil Electrical Values</i>								
UL CSA	24/60		0.63	0.38	19	6	D006	4.6	1.30
	110/50	A024	0.13	0.08	475	12	D012	19	0.63
	120/60	E110 A120	0.13	0.08	475	24	D024	75	0.32
	220/50	E220 E240	0.07	0.04	2030	48	D048	294	0.16
	240/50	A240	0.06	0.04	2714	125	D125	2030	0.06
	240/60		0.06	0.04	2000				
<b>LOW-WATT OPTION 027 &amp; 043</b>									
							D006	47	0.125
							D012	193	0.063
							D024	724	0.031
							D048	2310	0.017
UL CSA	24/50		0.21	0.16	78				
	24/60		0.19	0.13	78				
	110/50	E024 A024	0.045	0.035	1715	12 24	D012	47	0.24
	110/60	E110 A110	0.041	0.028	1715	48	D024	193	0.12
	120/60	A120 E220	0.042	0.032	1715		D048	724	0.06
	220/50	A220 A240	0.023	0.017	7750				
	220/60		0.023	0.017	7750				
	240/60		0.021	0.016	7750				
<b>HAZARDOUS LOCATION</b>									
UL CSA	24/60		0.63	0.38	19	6	D006	4.6	1.30
	110/50	A024	0.13	0.08	475	12	D012	19	0.63
	120/60	E110 A120	0.13	0.08	475	24	D024	75	0.32
	220/50	E220 E240	0.07	0.04	2030	48	D048	294	0.16
	240/50	A240	0.06	0.04	2714	125	D125	2030	0.06
	240/60		0.06	0.04	2000				

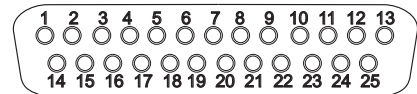

Wire Location DB 25 CONNECTOR		
Pin No.	Wire No.	Function
1	1	Valve 1, SOL A12
14	1	Valve 1, SOL B14
2	2	Valve 2, SOL A12
15	2	Valve 2, SOL B14
3	3	Valve 3, SOL A12
16	3	Valve 3, SOL B14
4	4	Valve 4, SOL A12
17	4	Valve 4, SOL B14
5	5	Valve 5, SOL A12
18	5	Valve 5, SOL B14
6	6	Valve 6, SOL A12
19	6	Valve 6, SOL B14
7	7	Valve 7, SOL A12
20	7	Valve 7, SOL B14
8	8	Valve 8, SOL A12
21	8	Valve 8, SOL B14
9	9	Valve 9, SOL A12
22	9	Valve 9, SOL A14
10	10	Valve 10, SOL A12
23	10	Valve 10, SOL B14
11	11	Valve 11, SOL A12
24	11	Valve 11, SOL B14
12	12	Valve 12, SOL A12
25	12	Valve 1, SOL B14
13	C	COMMON

C5  
&  
C7

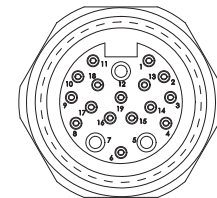

Wire Location 19 Pin CONNECTOR		
Pin No.	Wire No.	Function
1	VIOLET	Valve 1, SOL A12
2	RED	Valve 1, SOL B14
3	GREY	Valve 2, SOL A12
4	RED/BLUE	Valve 2, SOL B14
6	GREEN	Valve 3, SOL A12
8	WHITE/GREEN	Valve 3, SOL B14
9	WHITE/YELLOW	Valve 4, SOL A12
10	WHITE/GREY	Valve 4, SOL B14
11	BLACK	Valve 5, SOL A12
13	YELLOW/BROWN	Valve 5, SOL B14
14	BROWN/GREEN	Valve 6, SOL A12
15	WHITE	Valve 6, SOL B14
16	YELLOW	Valve 7, SOL A12
17	PINK	Valve 7, SOL B14
18	GREY/BROWN	Valve 8, SOL A12
19	GRAY/PINK	Valve 8, SOL B14
5	BLUE	COMMON
12	GREEN/YELLOW	GROUND
7	BROWN	NONE

C9

### Surge Suppression Diode C5, C7 & C9

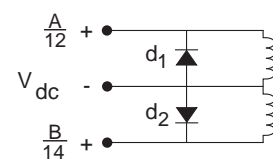

# Dimensions

## Manifolds, Stacking

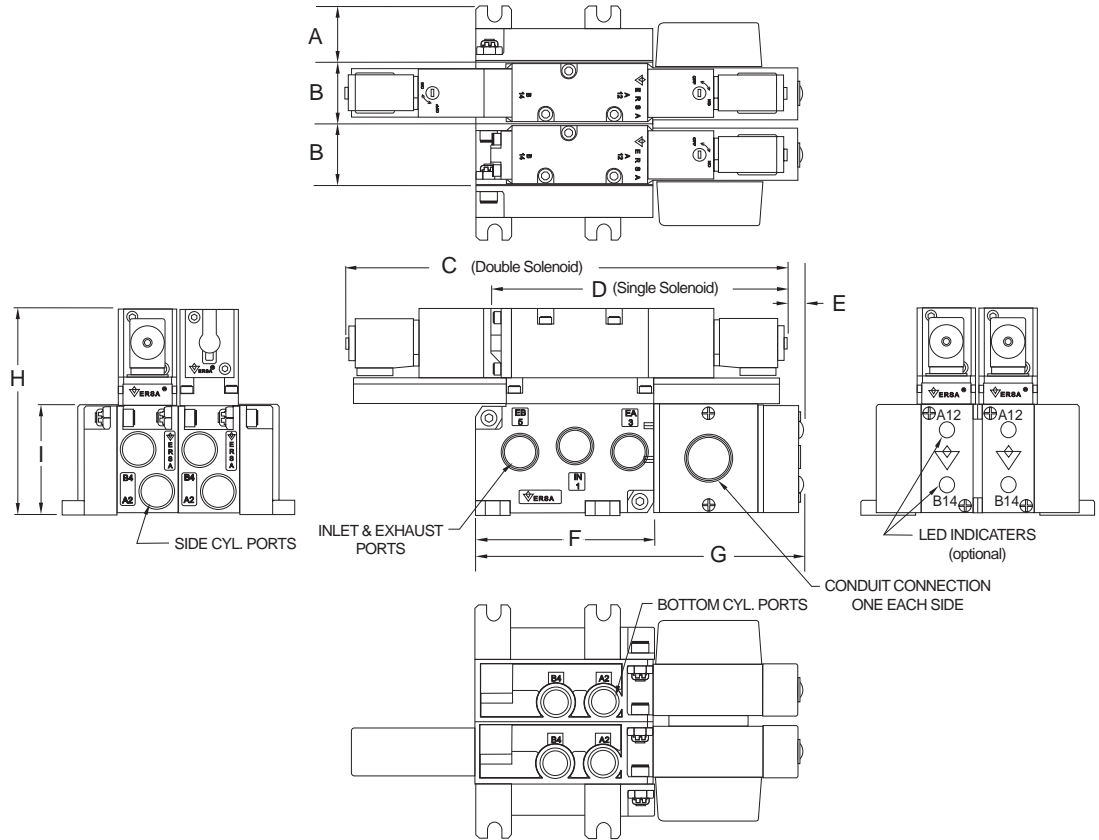

C5, C7 & C9 Stacking Manifolds Dimensions												
SERIES	A	B	C	D	E	F	G	H	I	Cylinder Ports	Inlet Ports	Conduit Hub
C5	1" (25.4)	.95" (24.1)	7.40" (188.1)	4.76" (121.0)	.33" (8.4)	2.60" (66.0)	5.35" (135.9)	3.79" (96.3)	2.00" (50.8)	Side	1/4" NPT	1/2" NPT
										1/8" or 1/4"		
										Bottom		
C7	1" (25.4)	1.12" (28.5)	8.03" (204)	5.39" (136.9)	.33" (8.4)	3.24" (82.4)	6.00" (152.4)	3.75" (82.4)	2.00" (50.8)	Side	3/8" NPT	1/2" NPT
										1/4" or 3/8"		
										Bottom		
C9	1.75" (44.5)	2.18" (55.4)	10.75" (273.1)	7.32" (185.9)	0.25" (6.4)	7.88" (200.2)	NA	7.86" (199.6)	3.20" (81.28)	Side	3/4" NPT	1" NPT
										1/2"		
										Bottom		
										1/2"		

Metric dimensions in mm shown in parenthesis.



## Valves Sideported & Fixed Length Manifold

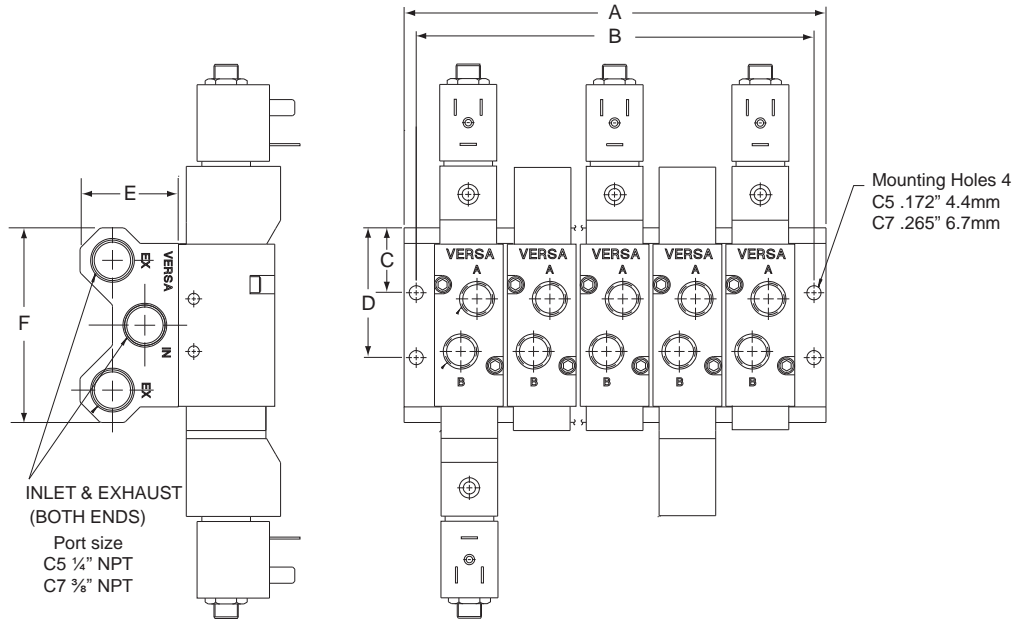

C5 & C7 Fixed Length Manifolds Dimensions																						
Series	Length*																Mounting Holes	Height	Width			
	2 Station		3 Station		4 Station		5 Station		6 Station		7 Station		8 Station		9 Station					10 Station		
	A	B	A	B	A	B	A	B	A	B	A	B	A	B	A	B	A	B	C	D	E	F
C5	2.50	2.19	3.44	3.13	4.38	4.06	5.31	5.0	6.25	5.93	7.19	6.88	8.13	7.81	8.13	9.06	10.0	9.69	1.48	2.27	3.00	1.25
C7	3.13	2.75	4.25	3.88	5.38	5.0	6.50	6.13	7.63	7.25	8.75	8.38	9.88	9.50	11.0	10.63	12.13	11.75	1.0	2.0	3.00	1.50

\* Dimensions: Inches

Fixed Length Manifold Part Number		
Valve Series	Part Number	Port Size
C5	C5M-4300-(*number of stations)	1/4" NPT
C7	C7M-4400-(*number of stations)	3/8" NPT

\*Indicate number of stations, 2 to 10

**NOTE:** manifolds available with ISO threads, consult factory.

## Valves, Sideported

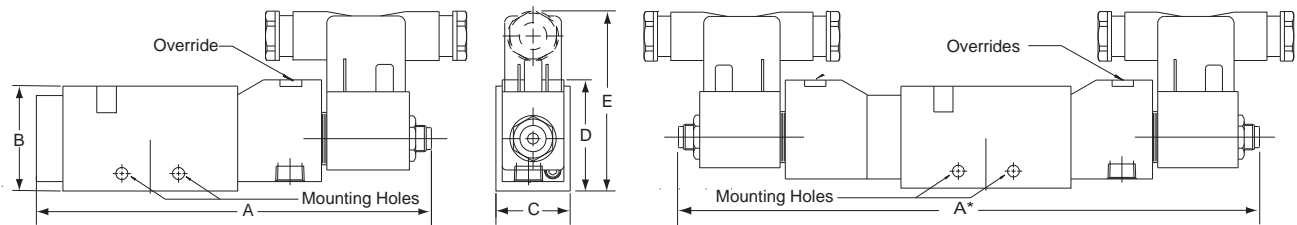

	A	A*	B	C	D	E	Port Size	Mounting Holes Diameter
C5	5.03" (127.7)	7.92" (201.2)	1.25" (31.8)	0.88" (22.4)	1.46" (37.2)	3.71" (94.2)	1/8" NPT (G3/8)	0.144" #8 Screw
C7	5.65" (143.6)	8.55" (217.1)	1.50" (38.1)	1.06" (27.0)	1.59" (40.4)	4.02" (102.2)	1/4" NPT (G1/4)	0.172" #8 Screw
C9	7.45" (189)	10.75" (273)	2.25" (57)	1.75" (44)	2.25" (57)	2.57" (63)	1/2" NPT	0.27" 1/4" Screw

**NOTE:** valves available with ISO threads, consult factory.

Metric dimensions in mm, shown in parenthesis.

# Dimensions

## Valves, Pilot & Manual

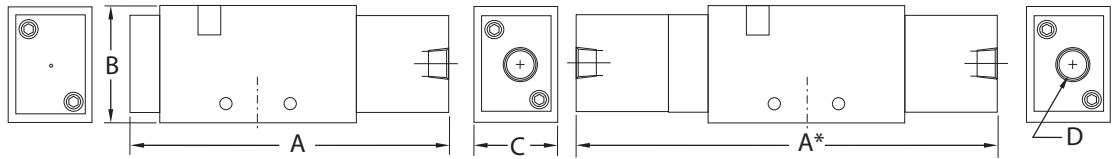

	A	A*	B	C	D Pressure Pilot Port	Inlet, Exhaust, & Cylinder Ports
C5	3.44" (87.3)	4.75" (120.7)	1.25" (31.8)	0.88" (22.2)	1/8" NPT (G1/8)	1/8" NPT (G1/8)
C7	4.06" (103.2)	5.38" (136.6)	1.50" (38.1)	1.06" (27.0)	1/8" NPT (G1/8)	1/4" NPT (G1/4)
C9	5.88" (149)	7.88" (200)	1.73" (43.9)	2.0" (50.8)	1/8" NPT	1/2" NPT

Metric dimensions in mm shown in parenthesis.

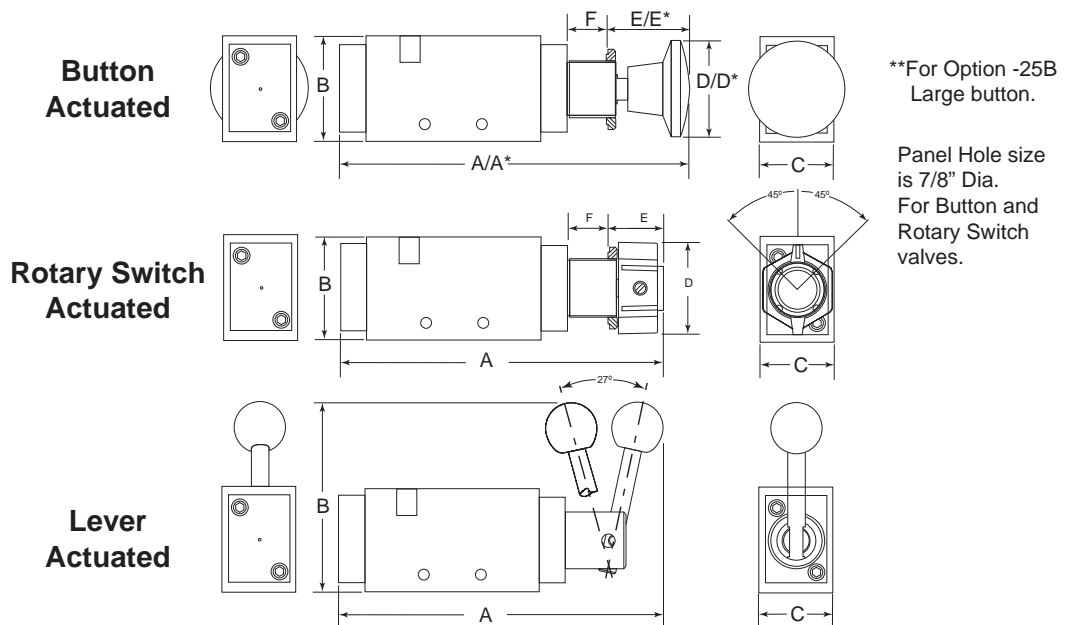

		A	A*	B	C	D	D** Large Button	E	E*	F	Inlet, Exhaust, & Cylinder Ports
Button Actuated Valves	C5	4.37" (111.0)	4.66" (118.4)	1.25" (31.8)	0.88" (22.2)	1.38" (35.1)	1.81" (46.0)	0.88" (22.4)	0.17" (4.3)	0.56" (14.2)	1/8" NPT G1/8
	C7	4.99" (126.8)	5.28" (134.1)	1.50" (38.1)	1.06" (27.0)	1.38" (35.1)	1.81" (46.0)	0.88" (22.4)	0.17" (4.3)	0.56" (14.2)	1/4" NPT G1/4
Rotary Switch Actuated Valves	C5	3.96" (100.6)	--	1.25" (31.8)	0.88" (22.2)	--	--	0.78" (19.8)	--	2.00" (50.8)	1/8" NPT G1/8
	C7	4.58" (116.3)	--	1.50" (38.1)	1.06" (27.0)	--	--	0.78" (19.8)	--	2.62" (67.0)	1/4" NPT G1/4
Lever Actuated Valves	C5	4.04" (102.7)	--	2.63" (66.8)	0.88" (22.2)	--	--	--	--	--	1/8" NPT G1/8
	C7	4.04" (102.7)	--	2.75" (69.9)	1.06" (27.0)	--	--	--	--	--	1/4" NPT G1/4

Metric dimensions in mm shown in parenthesis.

**NOTE:** valves available with ISO threads, consult factory.

# Repair Kits

## Series C5 Valves

Repair Kit No.	For valve type
C-4202-SI	CSI-
C-4202-SL	CSL-
C-4202-ZI	CZI-
C-4202-ZL	CZL-
C-4203-BI	CBI-w/ 3 spool
C-4203-BL	CBL- w/ 3 spool
C-4203-UI	CUI-w/ 3 spool
C-4203-UL	CUL-w/ 3 spool
C-4204-BI	CBI-w/ 4 spool
C-4204-BL	CBL- w/ 4 spool
C-4204-UI	CUI-w/ 4 spool
C-4204-UL	CUL-w/ 4 spool
C-4222-PP	CGG- & CPP-
C-4222-SP	CSG- & CSP-
C-4223	CXX- & CJJ- w/ 3 spool
C-4224	CXX- & CJJ- w/ 4 spool

## Series C7 Valves

Repair Kit No.	For valve type
C-4302-SI	CSI-
C-4302-SL	CSL-
C-4302-ZI	CZI-
C-4302-ZL	CZL-
C-4303-BI	CBI-w/ 3 spool
C-4303-BL	CBL- w/ 3 spool
C-4303-UI	CUI-w/ 3 spool
C-4303-UL	CUL-w/ 3 spool
C-4304-BI	CBI-w/ 4 spool
C-4304-BL	CBL- w/ 4 spool
C-4304-UI	CUI-w/ 4 spool
C-4304-UL	CUL-w/ 4 spool
C-4322-PP	CGG- & CPP-
C-4322-SP	CSG- & CSP-
C-4323	CXX- & CJJ- w/ 3 spool
C-4324	CXX- & CJJ- w/ 4 spool

## Series C9 Valves

Repair Kit No.	For valve type
C-4522-PP	CGG- & CPP-
C-4522-SP	CSG- & CSP-
C-4523	CXX- & CJJ- w/ 3 spool
C-4524	CXX- & CJJ- w/ 4 spool

VALVE TYPE	SERIES	SOLENOID TYPE	COIL TYPE	COIL PRODUCT NUMBER
Manifold Mounting or Body ported	C5 C7	Standard	3 spade terminals **	P-1005-02-HC-(* )
			Wire Leads	P-1005-02-243-(* )
			Wire Leads with 1/2" NPT conduit connection	P-1005-02-228L-(* )
	C5 C7	Low-Watt	3 spade terminals ††	†P-1520-02-027-HC-(* ) †P-1520-02-043-HC-(* )
			Wire Leads	†P-1520-02-027-243-(* ) †P-1520-02-043-243-(* )
	C9	Standard	3 spade terminals ††	P-1580-02-HC-(* )

\* Add coil code from page 13

\*\* DIN connectors for this coil is P-1005-70-HC

† Match coil to valve product number using -027 or -043 designation (see page 7 for part number)

†† DIN connectors C5/C7 is P-1520-70-HC, C9 is P-1005-70-HC



Versa has been supplying the mobile industry with pneumatic and hydraulic components for over 65 years.

We have built a reputation for quality that is unsurpassed in the market for high performance solenoids, pneumatic relays, resets and pilot valves.

#### WARNINGS REGARDING THE DESIGN APPLICATION, INSTALLATION AND SERVICE OF VERSA PRODUCTS

The warnings below must be read and reviewed before designing a system utilizing, installing, servicing, or removing a Versa product. Improper use, installation or servicing of a Versa product could create a hazard to personnel and property.

#### DESIGN APPLICATION WARNINGS

Versa products are intended for use where compressed air or industrial hydraulic fluids are present. For use with media other than specified or for non-industrial applications or other applications not within published specifications, consult Versa.

Versa products are not inherently dangerous. They are only a component of a larger system. The system in which a Versa product is used must include adequate safeguards to prevent injury or damage in the event of system or product failure, whether this failure be of switches, regulators, cylinders, valves or any other system component. System designers must provide adequate warnings for each system in which a Versa product is utilized. These warnings, including those set forth herein, should be provided by the designer to those who will come in contact with the system.

Where questions exist regarding the applicability of a Versa product to a given use, inquiries should be addressed directly to the manufacturer. Confirmation should be obtained directly from the manufacturer regarding any questioned application prior to proceeding.

#### INSTALLATION, OPERATION AND SERVICE WARNINGS

Do not install or service any Versa product on a system or machine without first depressurizing the system and turning off any air, fluid, or electricity to the system or machine. All applicable electrical, mechanical, and safety codes, as well as applicable governmental regulations and laws must be complied with when installing or servicing a Versa product.

Versa products should only be installed or serviced by qualified, knowledgeable personnel who understand how these specific products are to be installed and operated. The individual must be familiar with the particular specifications, including specifications for temperature, pressure, lubrication, environment and filtration for the Versa product which is being installed or serviced. Specifications may be obtained upon request directly from Versa. If damages should occur to a Versa product, do not Operate the system containing the Versa product. Consult Versa for technical information.

#### LIMITED WARRANTY DISCLAIMER AND LIMITATION OF REMEDIES

Versa's Series products are warranted to be free from defective material and workmanship for a period of ten years from the date of manufacture, provided said products are used in accordance with Versa specifications. Versa's liability pursuant to that warranty is limited to the replacement of the Versa product proved to be defective provided the allegedly defective product is returned to Versa or its authorized distributor. Versa provides no other warranties, expressed or implied, except as stated above. There are no implied warranties of merchantability or fitness for a particular purpose. Versa's liability for breach of warranty as herein stated is the only and exclusive remedy and in no event shall Versa be responsible or liable for incidental or consequential damages.

Versa Products Company Inc.  
22 Spring Valley Road  
Paramus, New Jersey 07652  
USA  
Phone: 201-843-2400  
Fax: 201-843-2931

Versa BV  
Prins Willem Alexanderlaan 1429  
7321 GB Apeldoorn  
The Netherlands  
Phone: 011-31-55-368-1900  
Fax: 011-31-55-368-1909



www.versa-valves.com  
email: sales@versa-valves.com